



机械式前规技术
Mechanical front alignment technology

全球超过400台的安装量
可靠性久经考验
More than 400 installations worldwide, Proven reliability

C系列相册机的产品参数 FEATURES

C6		C6	
用纸种类	银盐、印刷、喷墨纸张	Paper	Silver salt、 printing、 inkjet paper
粘胶类型	热熔胶 (参考备注)	Glue	Hot melt
最大装订规格	18 x 18英寸(460X460mm)	Maximum book block	18"-18"(460*460mm)
最小装订规格	6 x 6英寸(152x152mm)	Minimum book block	6"-6"(152*152mm)
最大装订厚度	< 50毫米	Maximum thickness	<50mm
对裱速度(10x10英寸) (10张=20面)	1000张/小时 (无夹层) 700张/小时 (有夹层)	Speed(10"x10") (10sheets=20 pages)	1000sheets/hour (without cardboard) 700sheets/hour (with cardboard)
相纸使用标准范围	0.15-0.3毫米 (参考备注)	Thickness of paper	0.15-0.3mm
夹层厚度标准范围	0.35-0.5毫米 (参考备注)	Thickness of cardboard	0.35-0.5mm
设备工作环境要求	湿度65%-85%	Humidity	65%-85%
工作电压	220V50HZ单相	Power supply	220V 50HZ Single phase
最大功耗	2000瓦	Max. Power consumption	2000W
设备尺寸	长2.3米, 宽1米, 高1.4米	Machine dimension	2.3m(L)*1m(W)*1.4m(H)
最大搬运模块	长1.7米, 宽1米, 高1.4米	Maximum handling module	1.7m(L)*1m(W)*1.4m(H)
压缩空气的压力	>0.6mpa 200L/mim	Air compressor	>0.6mpa 200L/mim
设备重量为	650公斤	Weigh(net)	650KG
快速压平机	可选配	Inline presser	Optional
大容量夹层箱	可选配	High volume cardboard box	Optional
大容量纸箱	可选配	High volume paper box	Optional
备注：相纸放置高度<70mm、夹层放置高度≤70mm note: The height of paper<70mm/The height of cardboard≤70mm			

* 由于本司【官网/宣传单/宣传册/说明书】会随产品及技术的不断更新而相应变更，详情描述请以购买时的具体产品实物为准。

* As the company's [official website / flyer / brochure / manual] will be changed with the continuous updating of products and technologies, please refer to the specific products at the time of purchase for details.

广东易美图影像科技股份有限公司
 地址：广州市科学城天泰一路2号麦普科技园A栋306 邮编：510663
 电话：020-32052450-864 18026215657 传真：(8620) 32052450
 电子邮箱：sales@imetto.com 网站：http://www.imetto.com
 Imetto Digital Imaging Technology Co. Ltd
 A306,2Tiantaiyi Road,Guangzhou Science Park Guangzhou Science Park
 Tel:+86 20 320 52450-864 18026215657 Fax+8620 32052450
 Email: sales@imetto.com Http: www.imetto.com



自动测量纸长 Auto paper length detection

送纸过程中由光电传感器自动检测纸头纸尾，机器计算纸长，居中压痕与对折；用户无需输入任何尺寸参数，即可自动成册，操作便捷。

The photoelectric sensor automatically detects the paper head and tail during the paper feeding process

Calculate the paper length, center crease and half fold; The user does not need to enter any size, you can automatically form a book.

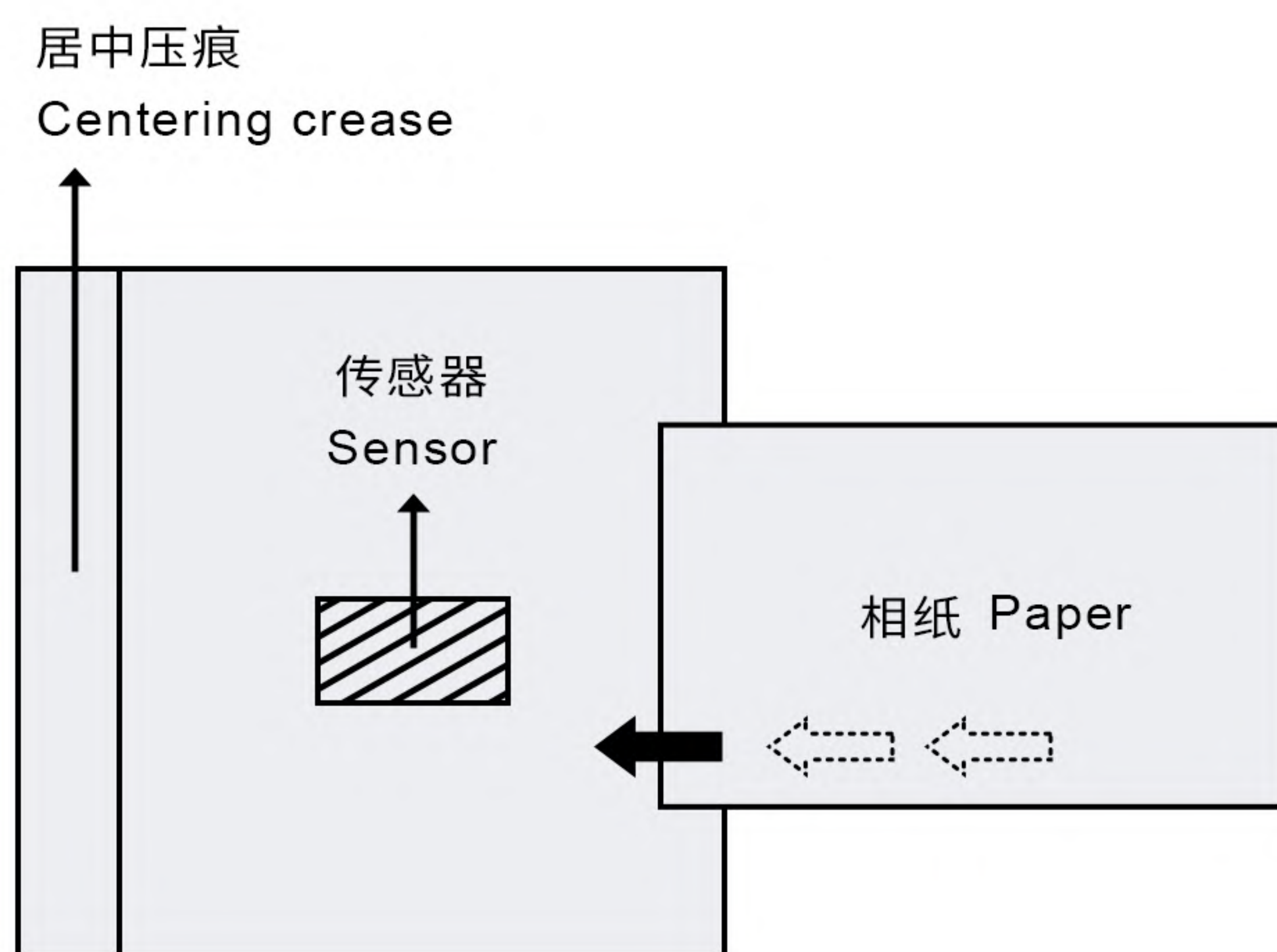

冷却模块 Cooling rack

由于相纸涂上热熔胶后，涂胶面温度会高于另一面，造成相纸弯曲变形，需大量时间另行压平定型。

易美图独有冷却模块技术，让相纸在相册制作后相对平坦定型，无需或大量节省相册压平定型时间，大大提高生产效率。

After the hot melt adhesive is applied to the photo paper, the temperature of the adhesive coating surface will be higher than that of the other side, resulting in bending and deformation of the photo paper, which requires a lot of time to flatten and shape.

Imetto's unique cooling module technology allows the photo paper to be relatively flat and shaped after the album is made, which saves a lot of time for the album flattening and shaping, and greatly improves the production efficiency.

冷却模块示意图

Cooling Module Schematic

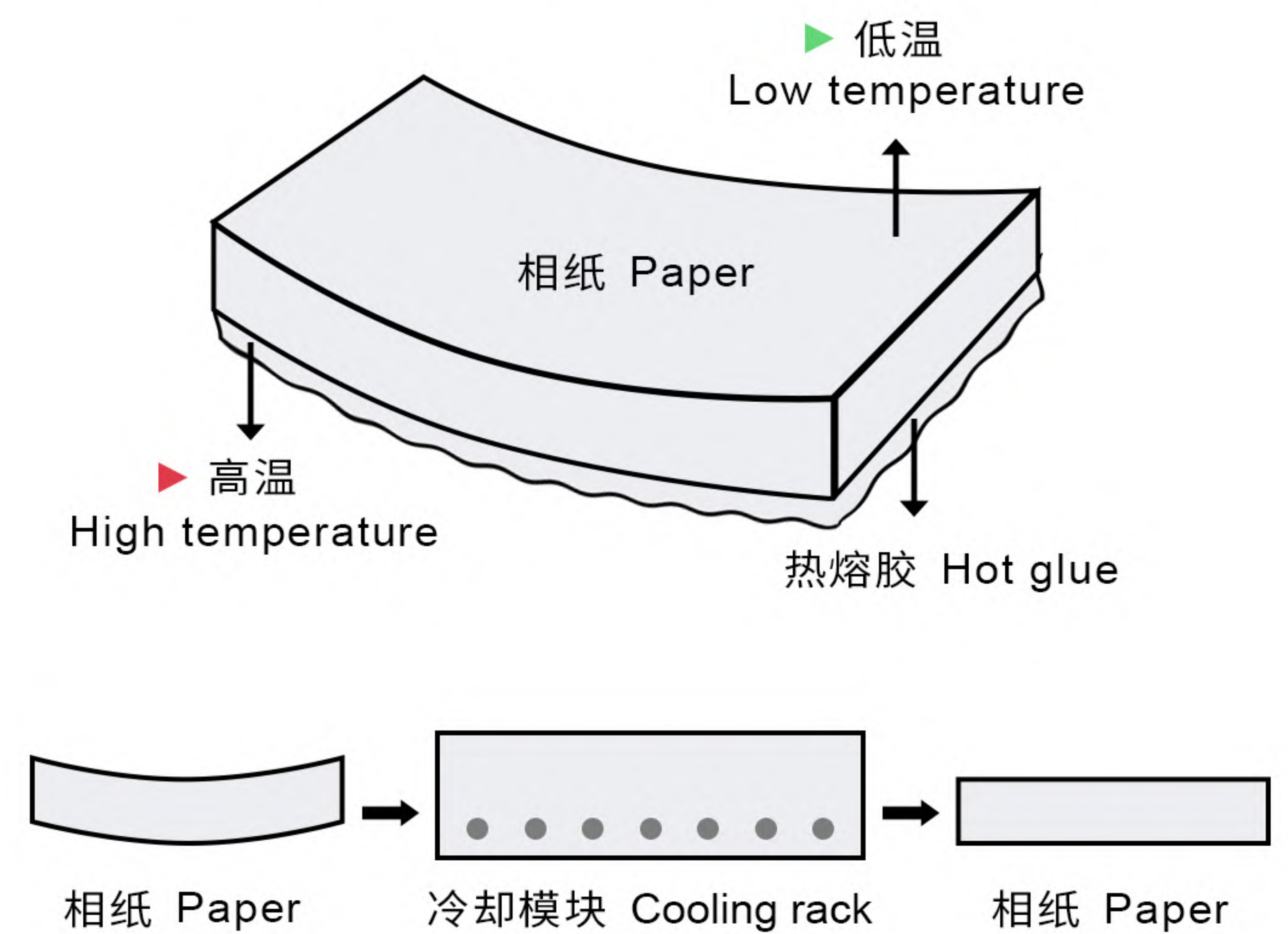

容易维护设计 Easy to maintain design

整机采用模块化设计，由几大部件构成，便于功能扩张以及日常的使用维护。需要日常维护的地方，都可以很方便的拉出，大大提高了你的日常维护效率。

Easy to use and maintain: The whole machine adopts modular design and is composed of several large parts, which is convenient for function expansion and daily use and maintenance.

Where daily maintenance is required, it can be easily pulled out, greatly improving your daily maintenance efficiency.

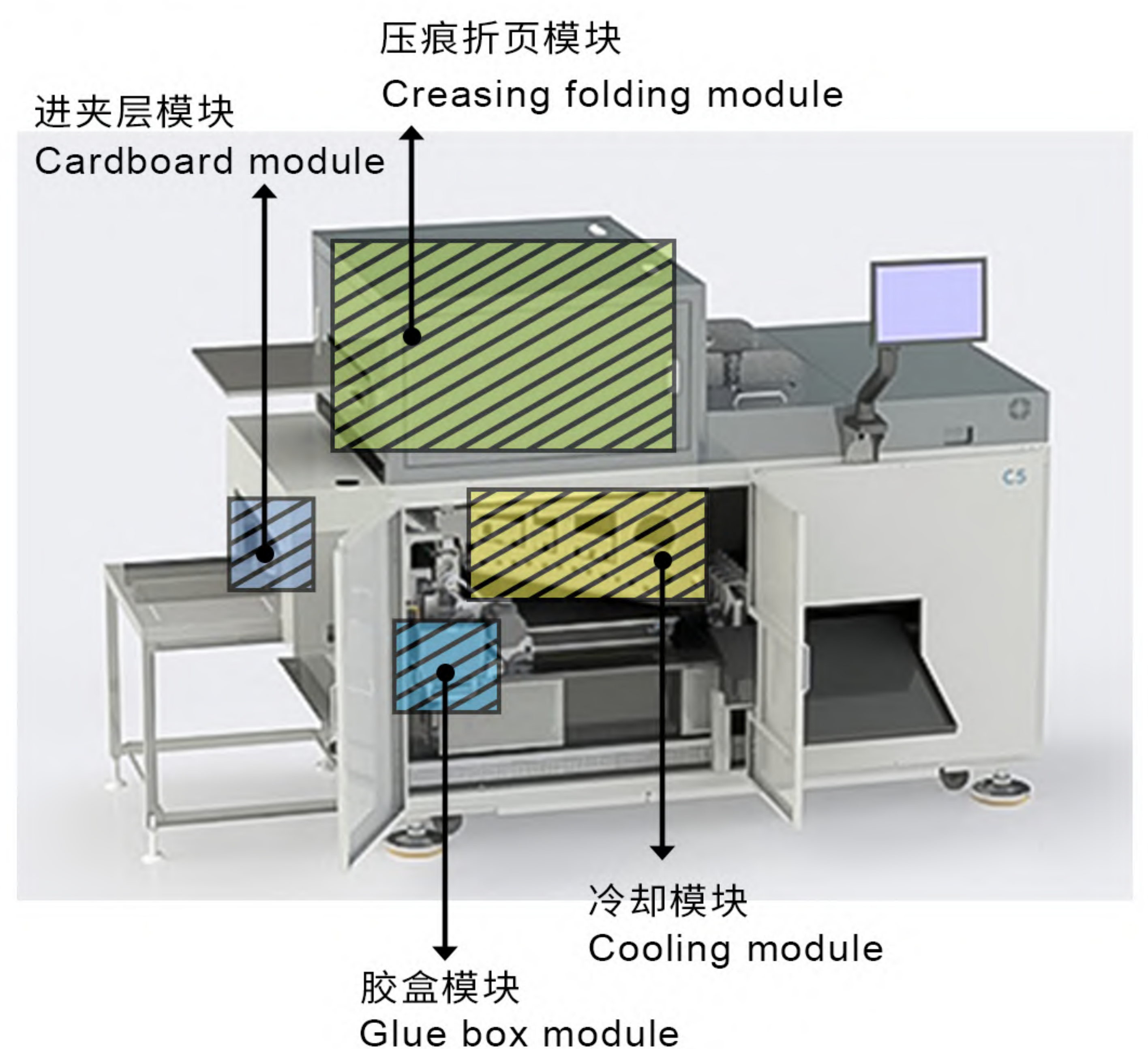

蝴蝶装订 Lay Flat Binding Technology

令人震撼的全景展示方式，易于翻开，完全展示！
Easy to Open and Full Display!



可加夹层 A Selectable Cardboard

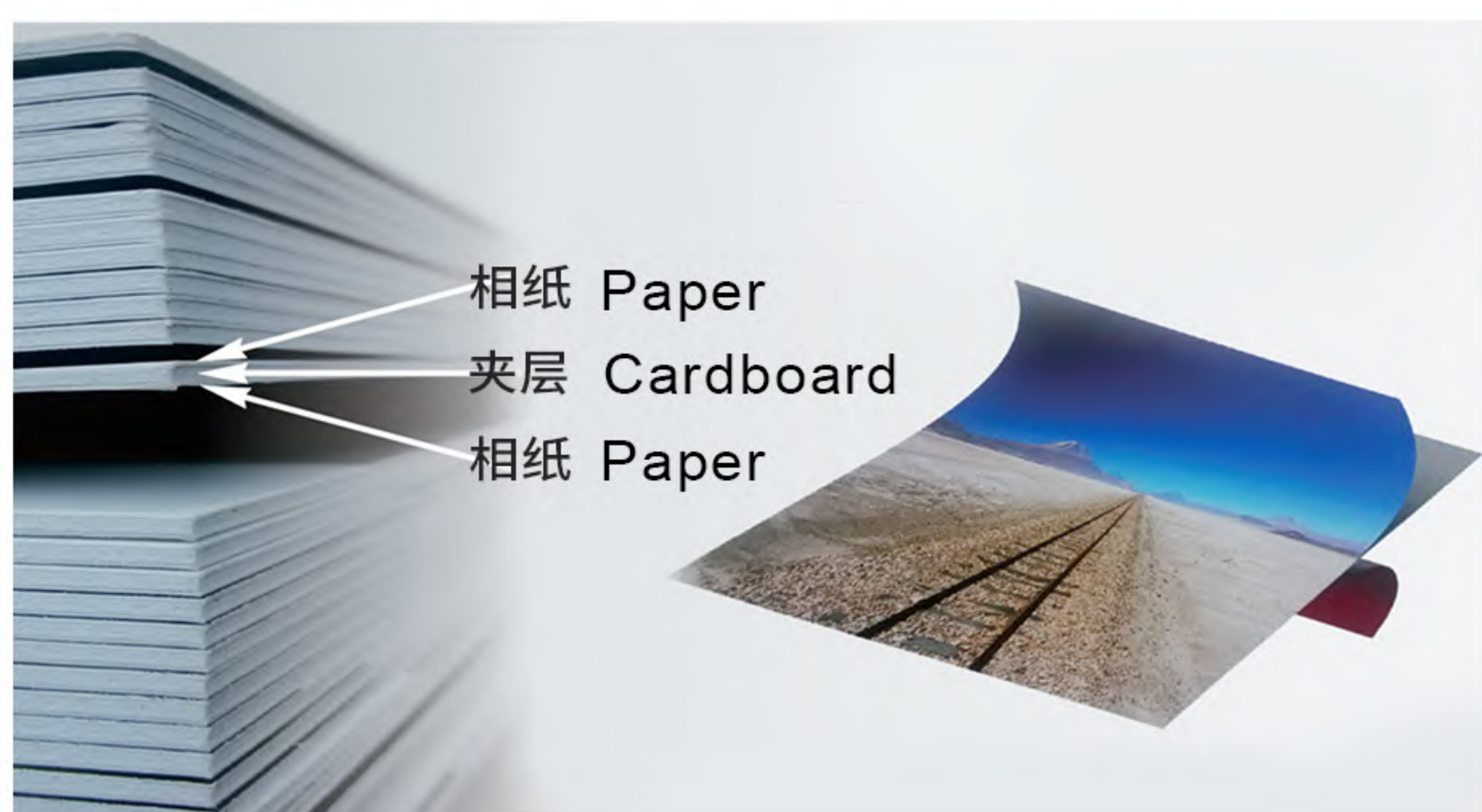

防划伤设计 Scratch proof design

呵护图片表面，避免因划伤导致的退货。
Protect the surface of the photo to avoid scratching.



热熔胶粘合 Hot melt Adhesive

本设备使用热熔胶粘合，它既能适应银盐相纸，也能适应打印、印刷纸。

热熔胶是一种环保的粘合剂，更符合国家越来越严格的环保要求，避开将来的环保风险。

- Best suited for silver halide paper and print paper.
- Compliance with environmental requirements.

快速压平固化 (选配功能, 部分机型适配) Quickly Pressed and Solidified (Optional)

我们独特配方的热熔胶，配合下面的压平机，使相册在两分钟内快速固化成型，无需再到其它机器长时间压平固化。

Adopting the hot melt to make a initial album. Then the Inline Presser solidifies and shapes the album quickly in 2 minutes.

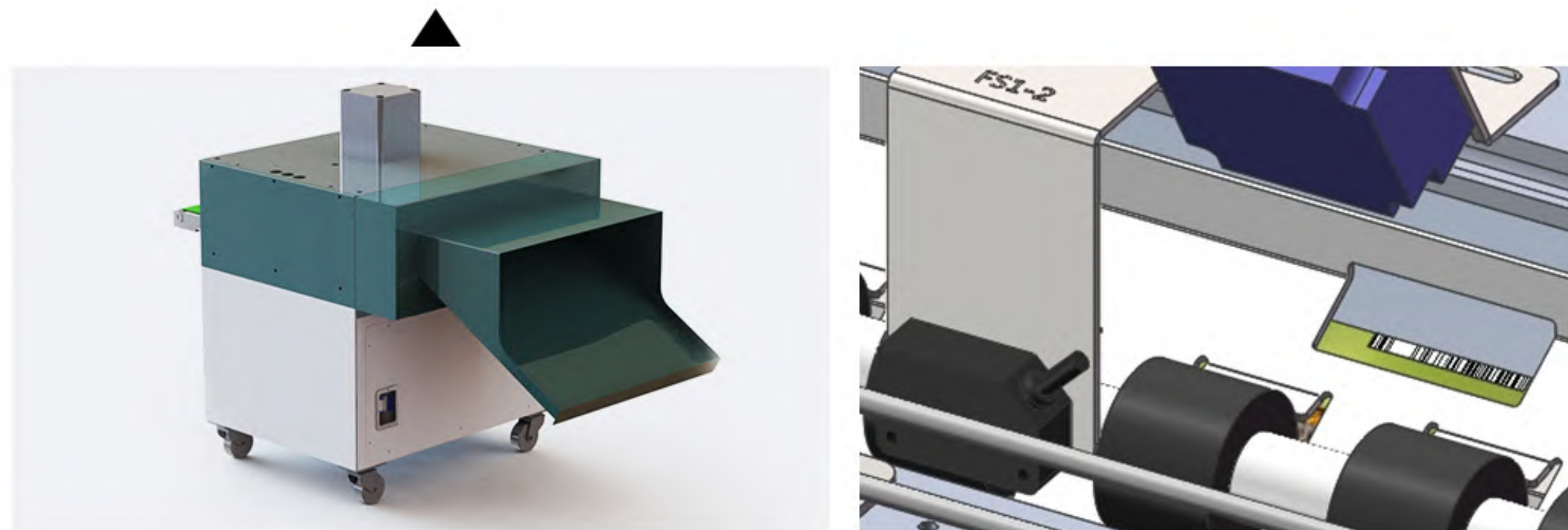

智能条码枪 (选配功能, 部分机型适配) Smart Barcode System (Optional)

相册机在进页过程中自动读取相片上的条码信息，获知该页面是属于哪一本相册及相册中的第几页，从而系统可作出顺序及漏页的警报，减少成册配页错误。

- Order number- identification of pages and sequence.
- It can make alerts of missing pages and sequence in time.
- Reduce the book with page and bound errors.

自动升降夹层箱 (选配功能, 部分机型适配) Automatic lifting cardboard box (Optional)

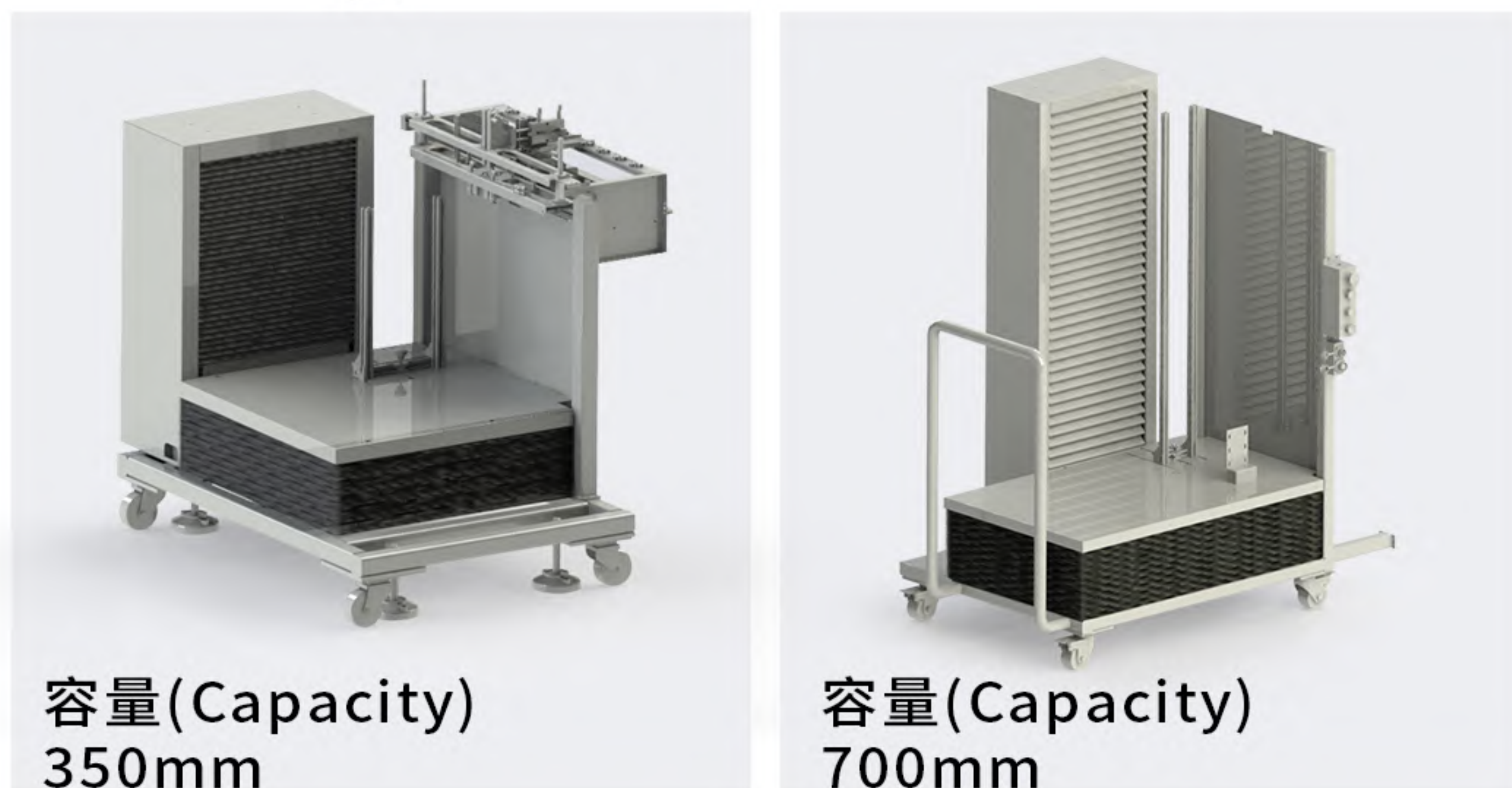

大容量纸箱 (选配功能, 部分机型适配) High volume paper feeding box (Optional)

作业流程 Work Flow

